



## OFFICIAL NOTICE AND AGENDA

Notice is hereby given that the Public Works Committee of the City of Stoughton, Wisconsin will hold a regular Public Works Meeting as indicated on the date, time and location given below.

Meeting of the: **Public Works Committee of the City of Stoughton**  
Date /Time: **Thursday, January 18, 2024 at 6:00 pm**  
Location: **This meeting will be available as virtual meeting only**  
**Stoughton Public Works Facility, 2439 County Rd A**  
Please join my meeting from your computer, tablet or smartphone.  
<https://meet.goto.com/478222605>  
You can also dial in using your phone.  
United States: +1 (872) 240-3212  
Access Code: 478-222-605

Members: Tom Majewski, Lisa Reeves, Ben Heili, Christina Wozniak Scanlon, Kay Rashka, Jordan Tilleson and Mayor Tim Swadley

### Item # CALL TO ORDER

1. Call to Order
2. Certification and Compliance with Open Meetings Law
3. Communications
4. Approve Minutes of the October 19, 2023 Meeting

### Item # OLD BUSINESS

5. Discussion Regarding the Tree Commission Structure

### Item # NEW BUSINESS

6. Overview of the New Public Works Structure
7. Review Welcome Sign Draft Concepts and Locations
8. Future Agenda Items
9. Adjourn

### ADJOURNMENT

cc: Council Members, City Leadership Team, City Attorney Matthew P. Dregne,  
Library Administrative Assistant Sarah Monette, Stoughton HUB  
[stoughtonreporter@wcinet.com](mailto:stoughtonreporter@wcinet.com), [stoughtoneditor@wcinet.com](mailto:stoughtoneditor@wcinet.com)

**NOTE:** AN EXPANDED MEETING MAY CONSTITUTE A QUORUM OF THE CITY COUNCIL



## Memorandum

To: Public Works Committee  
From: Brett Hebert, Director of Public Works  
Date: December 15, 2023  
Subject: Tree Commission

As we discussed at the September 21 Committee meeting, before the City hired an Arborist and subsequently a City Forester, a Tree Commission was formed to help oversee the care of the urban forest in Stoughton. Authority is granted to the Tree Commission through ordinance 64-14. In the past, before full time staff was hired to care for the urban forest, the Tree Commission members would have an active roll in hiring contractors, assessing tree care needs and planning for tree plantings throughout the community.

Since hiring a full-time professional tree care staff, the Arborist and subsequently City Forester have assumed all of the active duties in caring for the urban forest independent of the Tree Commission. The City Forester currently reports all activities to the Tree Commission during their monthly meeting. However, the Tree Commission has struggled to fill and maintain the five (5) citizen members required by ordinance. Furthermore, the participation level is very low from current members and often time there is no quorum during monthly scheduled meetings.

We also looked into the difference between a commission and committee. According to the League of Wisconsin Municipalities:

**“Municipalities may create other, non-statutory boards and commissions to address local concerns and issues. The size, composition, function and powers of such bodies are as set forth in the ordinances creating them.**

**Committees are different from boards and commissions. Committees are sub-units of municipal governing bodies. Committees are created by the governing body and typically are comprised exclusively of governing body members. The state statutes contain no provisions relating to the appointment of committees by the common council or village board.**

**Committees perform various functions such as: conduct investigations, review and make recommendations concerning pending legislative proposals, monitor and report on the work of various municipal departments and officers, study particular problems and recommend possible solutions, and otherwise perform detailed work which it would not be feasible for the entire governing body to accomplish or which would be too time consuming for the entire body to perform.**

**Committees are solely creatures of the governing body and consequently have only as much authority as delegated to them by the governing body. Typically, committees merely recommend actions to the governing body.”**

At the December 13, 2023 Tree Commission meeting, the group discussed what had been previously debated at the Public Works Committee meeting on October 19<sup>th</sup>, 2023. The Tree Commission discussed reducing the number of members to five (5), and going from a commission to a committee. The group was unanimous in their support to move to a five (5) person committee made up of three (3) citizen members, the City Forester, and a representative from the Public Works Committee.

With that being said, we would like your support in making the change from a eight (8) member Tree Commission to a five (5) person Tree Committee, made up of three (3) citizen members, the City Forester, and a representative from the Public Works Committee.

If approved, we will need to repeal and replace Ordinance 64-14, which will remove any language pertaining to the Tree Commission, and insert language pertaining to the care and maintenance of city owned trees. A new ordinance will then be written under Article IV, Boards, commissions and Committees, to create a Tree Committee and outline their responsibilities.

Regards,

Brett Hebert  
Director of Public Works



# City of Stoughton

## Department of Public Works

### 2023

**Mayor**  
Tim Swadley

**Director of Public Works**  
Brett Hebert

**Office Manager**  
Jennifer Wagner

**Parks and Recreation Superintendent**  
Open

**Fleet Manager/Mechanic**  
Bryce Bronstad

**Fleet Mechanic**  
Tony Garcia

**Street Supervisor**  
John Halverson

**Machine Operators**  
Dale Teigen  
John Udstuen - Lead  
Aaron Sokolik  
Andy Iverson  
Kurt Vinge  
Craig Brekken

**Yard Waste Attendants**  
John Foley

**City Forester**  
John Kemppainen

**Forestry Intern/Seasonal**  
Hunter Bahl

**Parks Supervisor**  
Mark Edwards

**Parks Machine Operator**  
Tye Michaels  
Mike Iverson

**Long Term Seasonals - 1199**  
Pete Vike  
Greg Knickmeier  
Julia Schuyler

**Short Term Seasonals - 599**  
Abygail Conway  
Kyla Kluge  
Valon Ashiku

**Horticulture - 599**  
Jeff Wingert

**Recreation Supervisor**  
Tony King

**Recreation Coordinator**  
Jeremy Kumbier

**Troll Beach Supervisor**

**Lifeguards**  
15

**Youth Center Manager**  
Greg Hoyte

**Youth Center Staff**  
Malik Michell  
Anna Smith

**Facilities Maintenance**  
Tracy Wam

**Custodian Full Time**  
Asher Pfanku

**Custodian Part Time**  
Jessica Hembrook

**Engineering Tech**  
Sue Eddy

Ful Time	22
Part Time	1
Long Term	3
Short Term	25
<b>Total</b>	<b>51</b>

# Welcome Sign Locations and Design Options



## Options to Consider



**S/F MONUMENT SIGN SPECIFICATIONS - CITY ENTRANCE - HWY 51&B, HWY 138**



- PMS 267c Violet
  - PMS 484c Rust Red
  - PMS 454c Cream
  - PMS 442c Gris
  - PMS Black C
- Texture Plus Cut Granite  
Light Tan

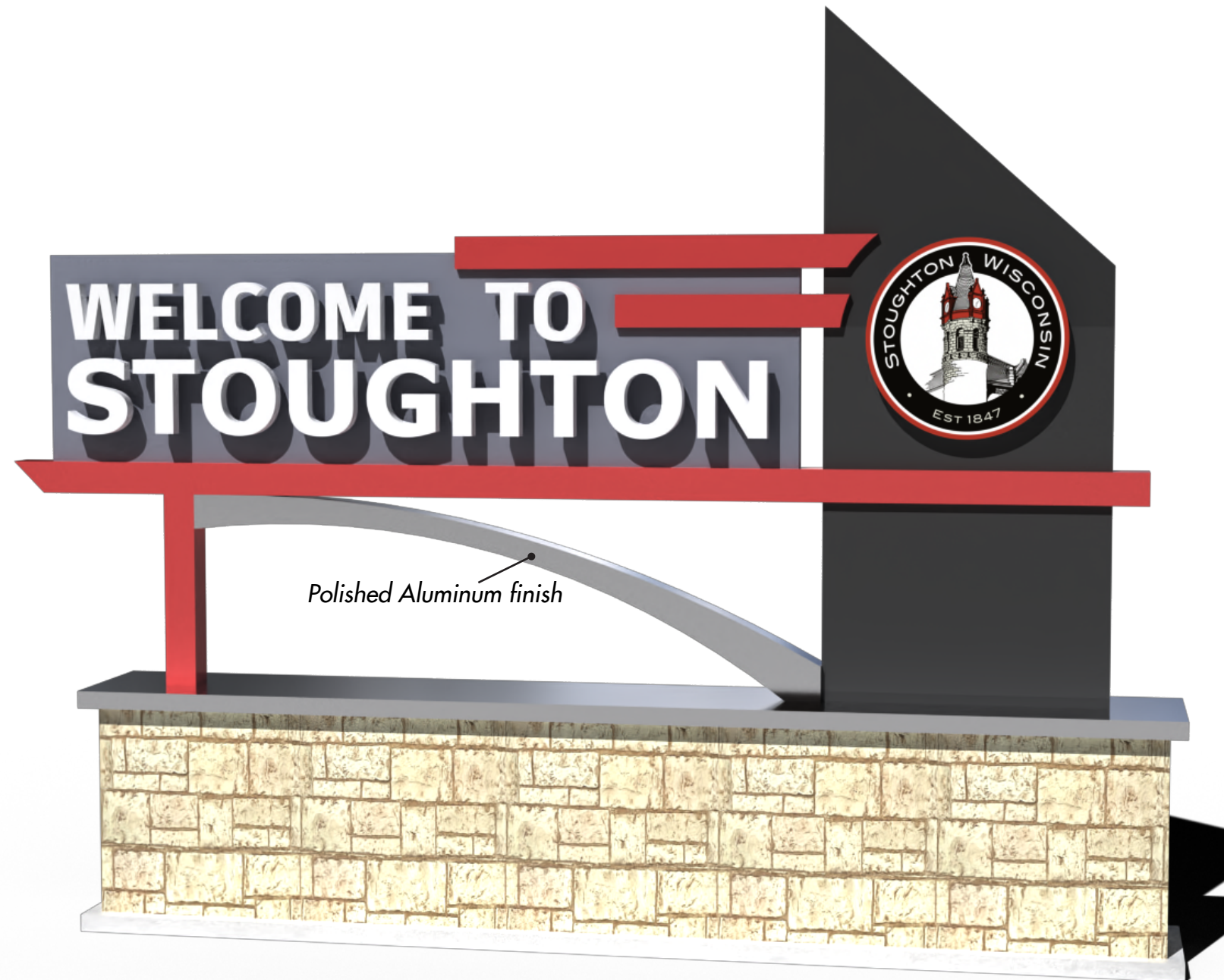

This original and unpublished design is copyrighted and the exclusive property of JNB Signs, Inc. and is not to be exhibited, copied or reproduced in whole or in part without written permission.

CLIENT :  
City of Stoughton

JOB LOCATION :  
Stoughton, WI

SALESMAN :  
Chris Campbell

DESIGNER :  
Scott B

REVISION HISTORY :  
Initial Drawing Release

A	DATE	REQUESTED BY	UPDATED BY
	8-16/23	CC	SB

General Revision			
B	DATE	REQUESTED BY	UPDATED BY

General Revision			
C	DATE	REQUESTED BY	UPDATED BY

General Revision			
D	DATE	REQUESTED BY	UPDATED BY

PRODUCTION APPROVAL :	
INITIAL	DATE

CLIENT SIGNATURE :	
	DATE

**10073-07a**  
Revision 00  
12-6/23

# S/F MONUMENT SIGN SPECIFICATIONS

**VOLTAGE**

120 Volts

277 Volts

**Survey Needed**

Detailed survey of existing location required prior to beginning manufacturing.



This original and unpublished design is copyrighted and the exclusive property of JNB Signs, Inc. and is not to be exhibited, copied or reproduced in whole or in part without written permission.

**CLIENT :**  
City of Stoughton

**JOB LOCATION :**  
Stoughton, WI

**SALESMAN :**  
Chris Campbell

**DESIGNER :**  
Scott B

**REVISION HISTORY :**  
Initial Drawing Release

A	DATE	REQUESTED BY	UPDATED BY
	8-16/23	CC	SB

B	DATE	REQUESTED BY	UPDATED BY

C	DATE	REQUESTED BY	UPDATED BY

D	DATE	REQUESTED BY	UPDATED BY

**PRODUCTION APPROVAL :**

INITIAL	DATE

**CLIENT SIGNATURE :**

	DATE

**10073-06a**  
Revision 00  
12-6/23

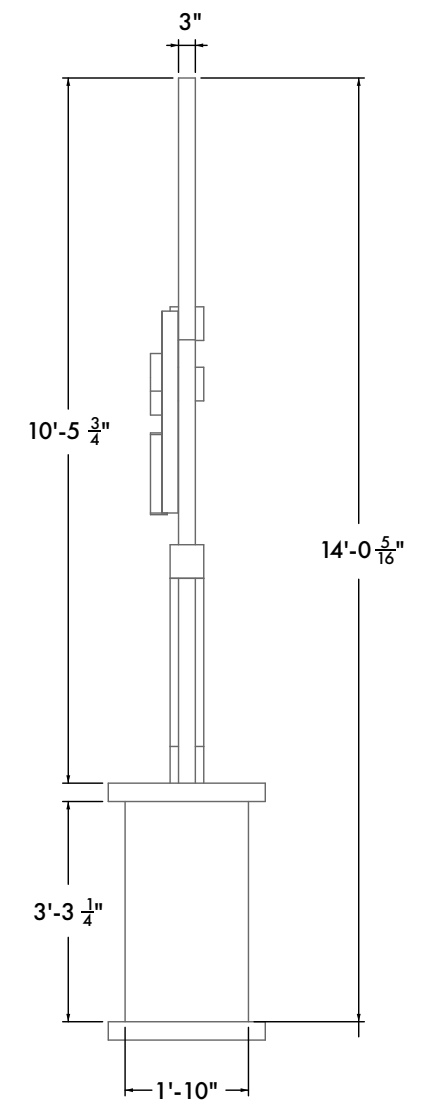
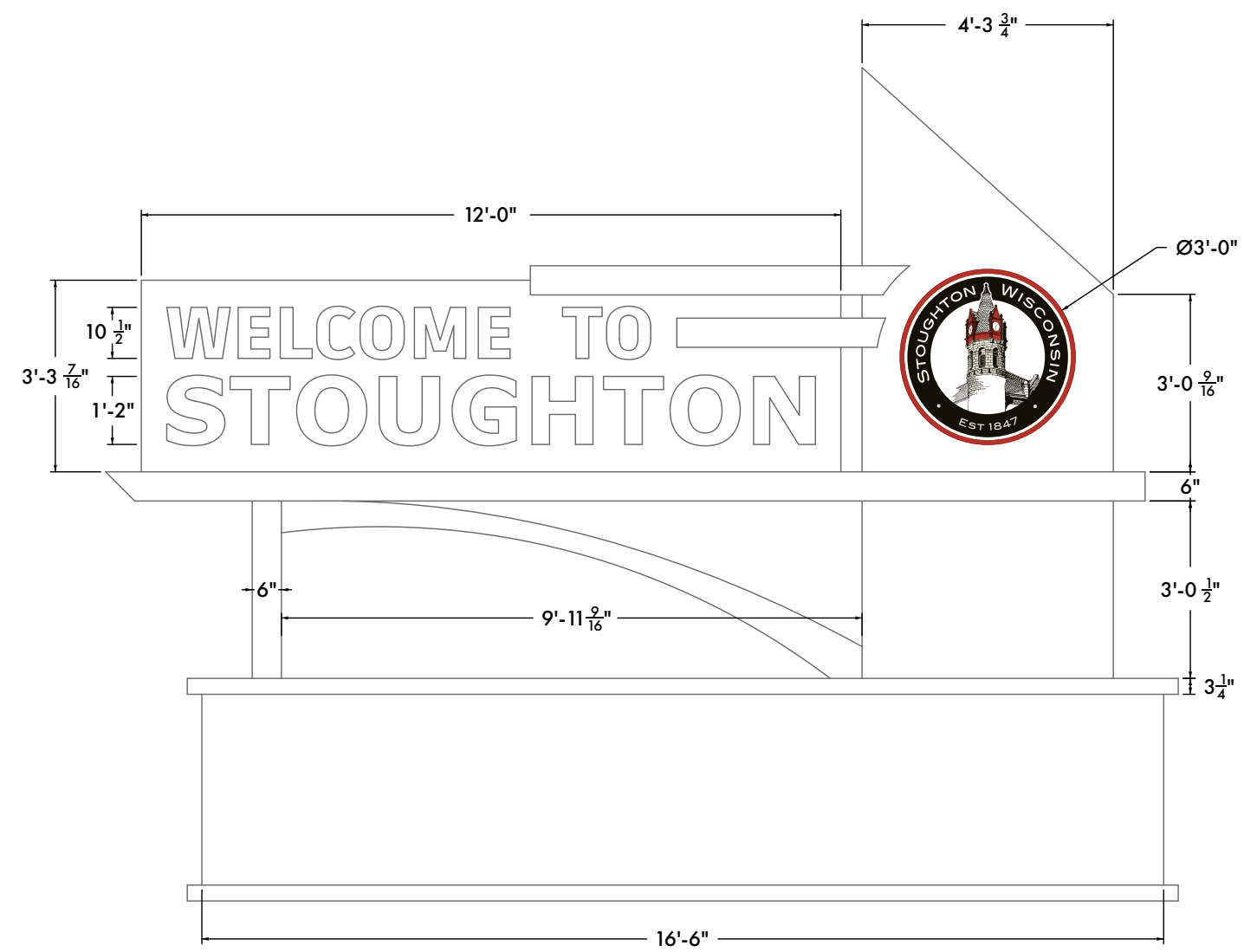
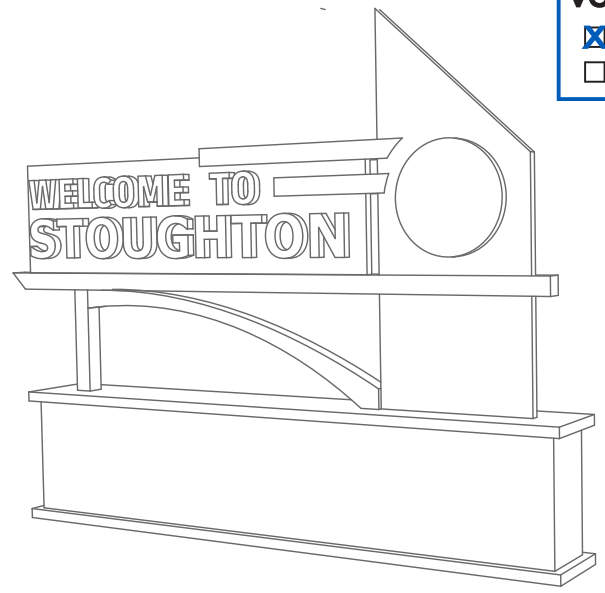
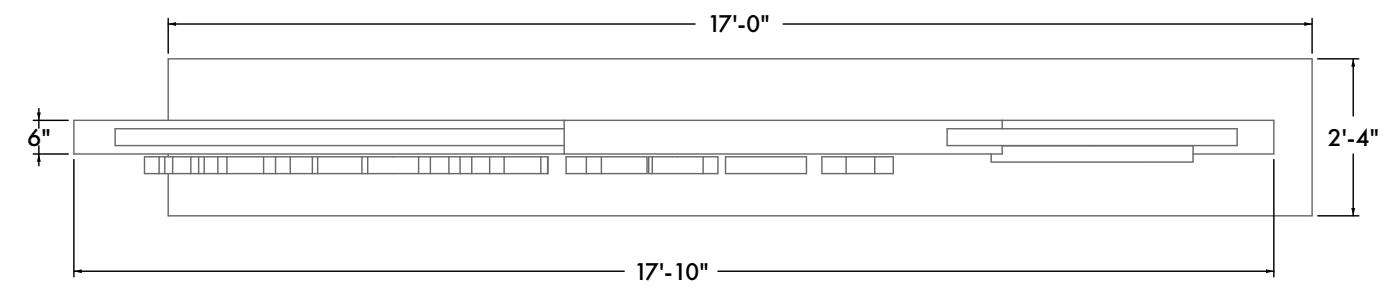

Highway 51 & B, Highway 138 Elevations

**SECTION A**  
Drawing Scale: N/A  
As shown on a 17" x 11" Tabloid

**S/F MONUMENT SIGN SPECIFICATIONS - CITY ENTRANCE - HWY 51&B, HWY 138**



- PMS 267c Violet
- PMS 484c Rust Red
- PMS 454c Cream
- PMS 442c Gris
- PMS Black C
- Texture Plus Cut Granite Light Tan



This original and unpublished design is copyrighted and the exclusive property of JNB Signs, Inc. and is not to be exhibited, copied or reproduced in whole or in part without written permission.

**CLIENT :**  
City of Stoughton

**JOB LOCATION :**  
Stoughton, WI

**SALESMAN :**  
Chris Campbell

**DESIGNER :**  
Scott B

**REVISION HISTORY :**  
Initial Drawing Release

	DATE	REQUESTED BY	UPDATED BY
A	8-16/23	CC	SB

General Revision

	DATE	REQUESTED BY	UPDATED BY
B			

General Revision

	DATE	REQUESTED BY	UPDATED BY
C			

General Revision

	DATE	REQUESTED BY	UPDATED BY
D			

**PRODUCTION APPROVAL :**

INITIAL	DATE

**CLIENT SIGNATURE :**

	DATE

**10073-06b**  
Revision 00  
12-7/23



# S/F MONUMENT SIGN SPECIFICATIONS

**VOLTAGE**

120 Volts

277 Volts

**Survey Needed**

Detailed survey of existing location required prior to beginning manufacturing.



This original and unpublished design is copyrighted and the exclusive property of JNB Signs, Inc. and is not to be exhibited, copied or reproduced in whole or in part without written permission.

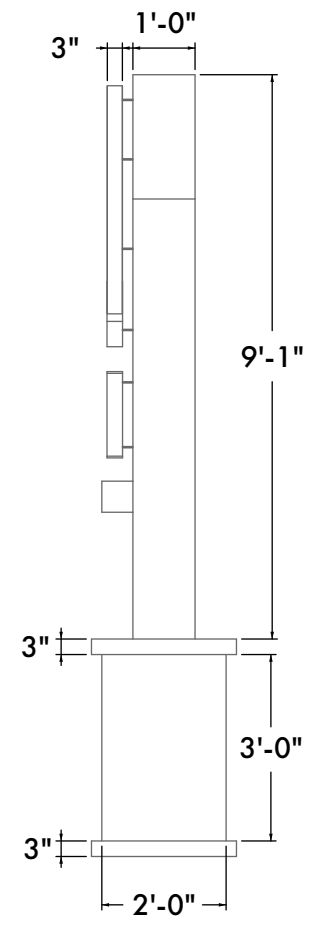
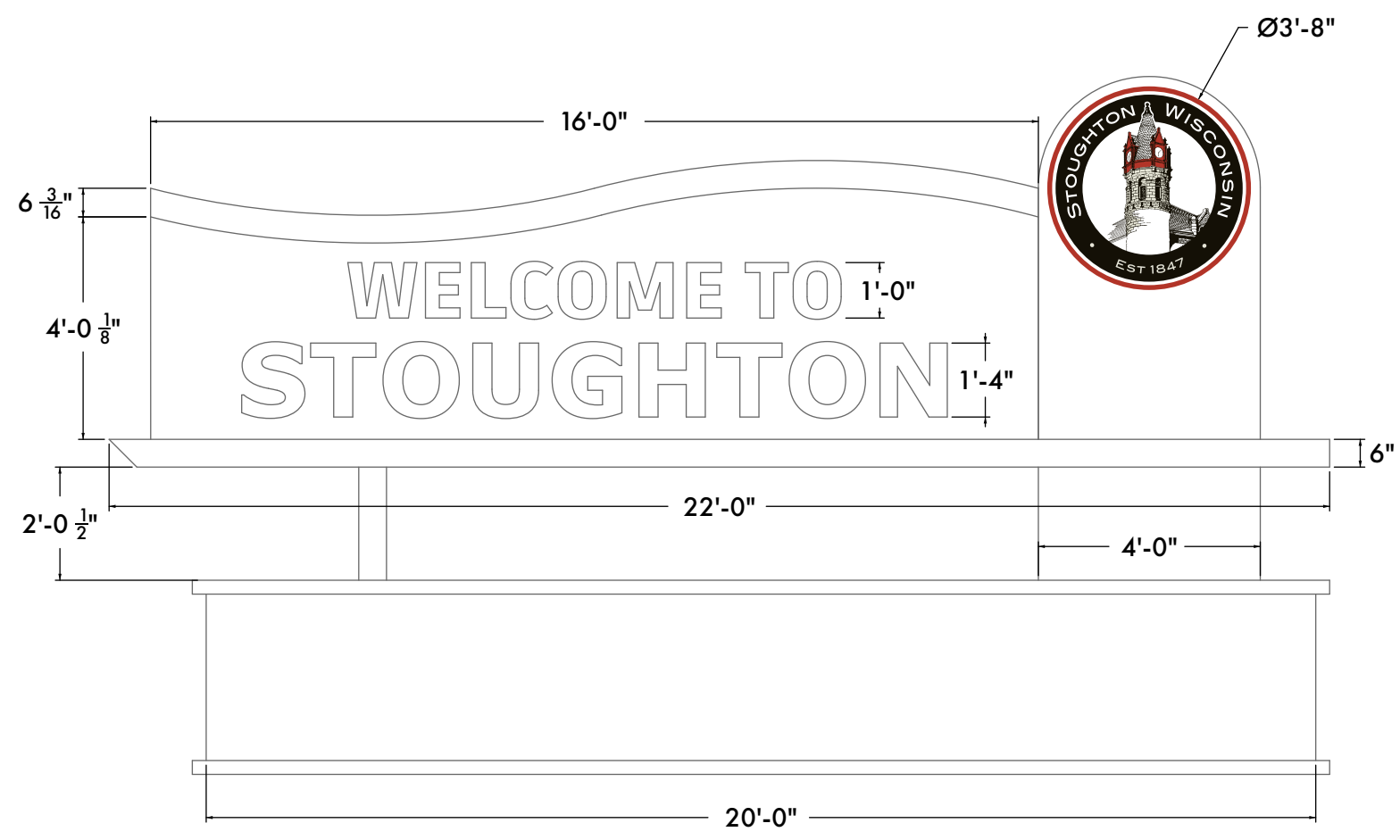
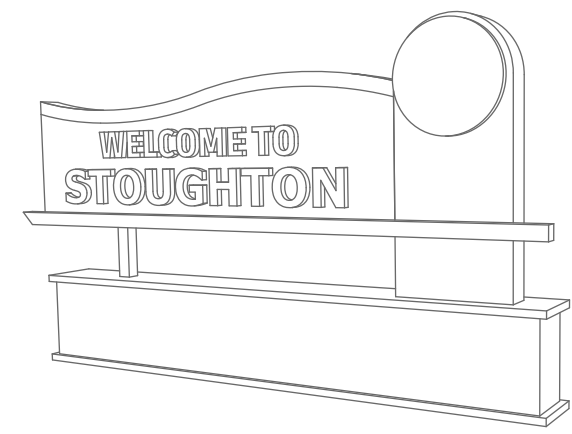
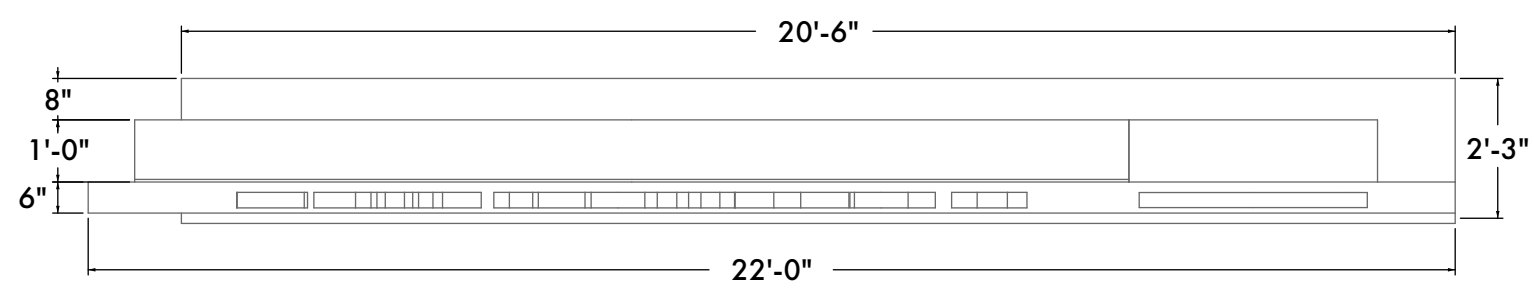

## SECTION A

Drawing Scale: N/A  
As shown on a 17" x 11" Tabloid

Highway 51 & B, Highway 138 Elevations

**CLIENT :**

City of Stoughton

**JOB LOCATION :**

Stoughton, WI

**SALESMAN :**

Chris Campbell

**DESIGNER :**

Scott B

**REVISION HISTORY :**

Initial Drawing Release

A	DATE	REQUESTED BY	UPDATED BY
	8-16/23	CC	SB

General Revision

B	DATE	REQUESTED BY	UPDATED BY

General Revision

C	DATE	REQUESTED BY	UPDATED BY

General Revision

D	DATE	REQUESTED BY	UPDATED BY

**PRODUCTION APPROVAL :**

INITIAL	DATE

**CLIENT SIGNATURE :**

DATE

**10073-06a**

Revision 00

12-6/23